

# Ultra

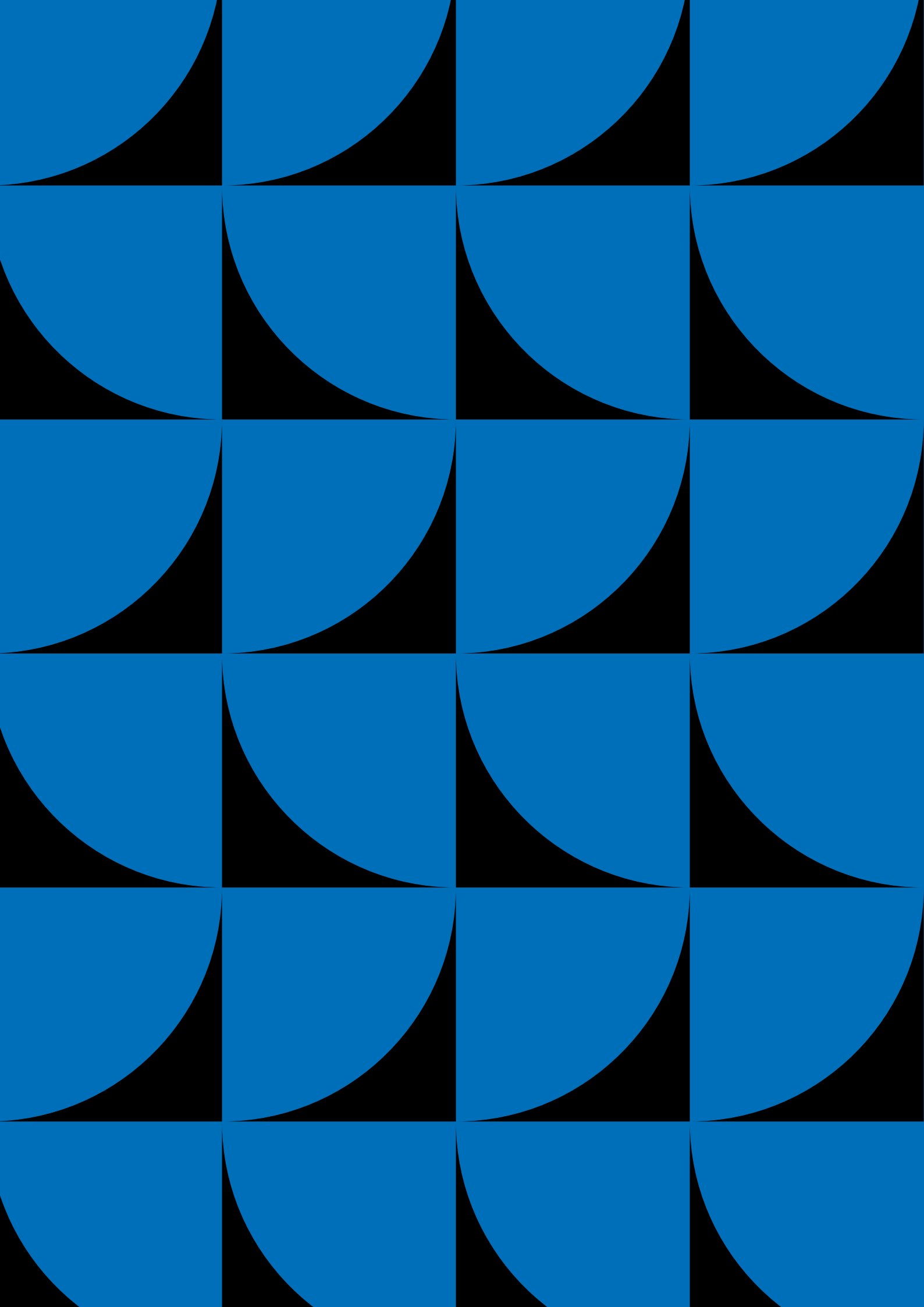

.mdd



**The ULTRA  
combines  
functionality  
with simplicity.  
Performing  
numerous  
functions stands  
the ULTRA for  
versatility.**



**Ultra K**  
seat

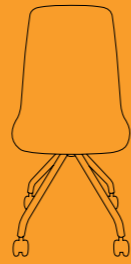

**Ultra K**  
base P7KM / P7KT



**Ultra F**  
seat

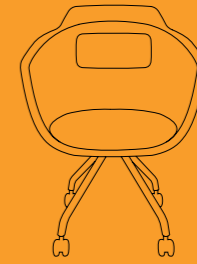

**Ultra F**  
base P7KM / P7KT

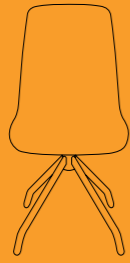

**Ultra K**  
base P7

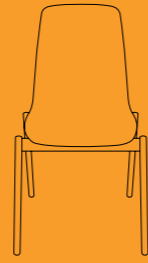

**Ultra K**  
base P1

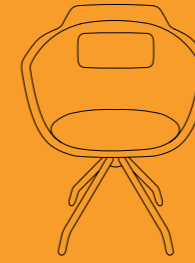

**Ultra F**  
base P7

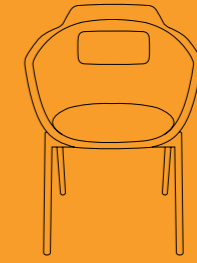

**Ultra F**  
base P1

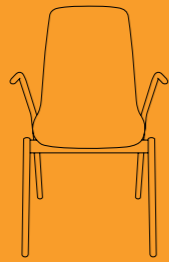

**Ultra K**  
base P2

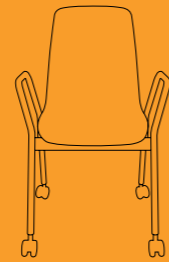

**Ultra K**  
base P3KM / P3KT

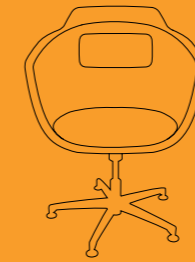

**Ultra F**  
base P11

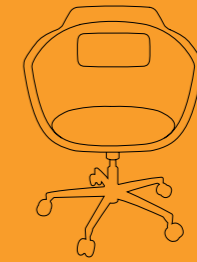

**Ultra F**  
base P11KM / P11KT

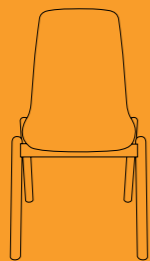

**Ultra KW**  
base P8

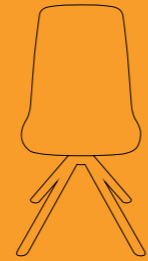

**Ultra KW**  
base P9

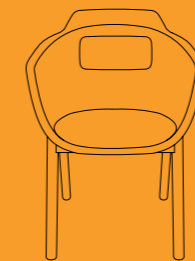

**Ultra FW**  
base P8

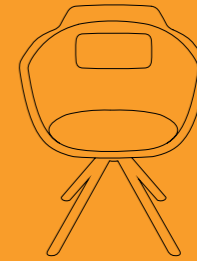

**Ultra FW**  
base P9

# Ultra

The ULTRA means many solutions. In an effort to provide chair that meets the expectation of all users we designed the ULTRA. With two seat types, various bases and armrests it is simple to adjust. Thanks to these features is the ULTRA multifunctional so that it can be used in a variety of settings from offices or public utilities to home interiors.

With sophisticated shell armchairs and minimalistic but eye-catching chairs to choose from combines the ULTRA functionality with working comfort. Designed with users comfort in mind features the ULTRA armrests that give

relief to arms as well as cushion fastened to the backrest adjusting to the way you sit. With a wide spectrum of fabrics and various types of frames offered is the ULTRA adaptable to any environment.

That's why it was honoured with the prize Dobry Wzór 2017 (Good Design) in the category WORK as its design was positively assessed regarding visual and functional features, economic features, innovativeness and comfort of use.



## Designer

Krystian Kowalski was born in Warsaw (1982) in an artistic family. He studied Product Design at Royal College of Art in London (MA 2010) and Faculty of Industrial Design at Akademia Sztuk Pięknych in Warsaw (MA 2007).

He gained professional experience when working for design studios in Warsaw, Łódź and in Milan. At Bellini studio he applied prototypes creating based methodology. Over the years 2009-2013 he co-created Kompott Studio, nominated for FX International Interior Design Award (2010) for Breakthrough Talent of the Year. Since 2013 he has been running design studio Krystian Kowalski Industrial Design.

He cooperates with leading furniture producers in the country and abroad. When designing he strives for smart solutions providing sophisticated and unobvious character of the product. His creative process is based on behaviour observations, in-depth analysis of trends and technologies choosing optimal solutions for the brand and production process. Krystian believes in a comprehensive action. He applies advanced computer technologies complemented by work with materials. Bold ideas are born in the studio with pattern shop and materialized in form of prototypes. His works were not only exhibited among others at Mint Gallery in London, MOCAK in Cracow and at Triennale in Milan, but also published in the most important branch magazines.



# Ultra Chair

**The ULTRA chair completes the range. As it provides fresh approach to guest seating it is perfect not only for**

**conference rooms but also for informal meeting or team-work areas.**

Incredibly comfortable foam seat comes in the variety of vibrant fabrics fostering concentration and efficiency.

glides, or with castors two of them can be additionally fitted with fixed armrest to achieve the highest level of sitting comfort. If you are looking for a seating unit with a homely feel choose one of two ULTRA variants with wooden frame.

The ULTRA chair includes several base options so that it is suitable for various needs. Available either with

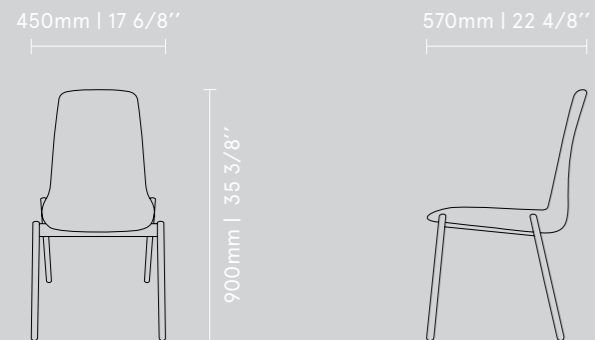



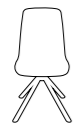

**ULTRA KW chair with P9 base**  
450 / 570 / 900  
17 6/8" / 22 4/8" / 35 3/8"



**ULTRA KW chair with P8 base**  
450 / 570 / 900  
17 6/8" / 22 4/8" / 35 3/8"



Ultra

Ultra

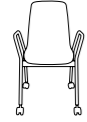

**ULTRA K chair with P3KM base**  
450 / 570 / 900  
17 6/8" / 22 4/8" / 35 3/8"

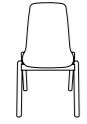

**ULTRA K chair with P1 base**  
450 / 570 / 900  
17 6/8" / 22 4/8" / 35 3/8"

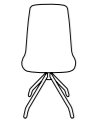

**ULTRA K chair with P7 base**  
450 / 570 / 900  
17 6/8" / 22 4/8" / 35 3/8"

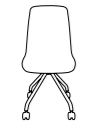

**ULTRA K chair with P7KT base**  
450 / 570 / 900  
17 6/8" / 22 4/8" / 35 3/8"





# Ultra Armchair

**Ergonomically-shaped shell seat made of moulded foam defines the ULTRA armchair. Crafted for maximum sitting**

Distinct seat stitching adds an element of elegance to its design. Three different base types make the seating solution extremely versatile.

Choose either four star metal base or experience the comfort of five star swivel base adjustable in height allowing for customised sitting position.

**comfort becomes the cushion fastened to the backrest the most striking feature.**

To meet all of your seating needs we fitted these bases with glides or castors. Following the Scandinavian design offers the ULTRA also a wooden frame suitable for office settings as well as for less formal areas.

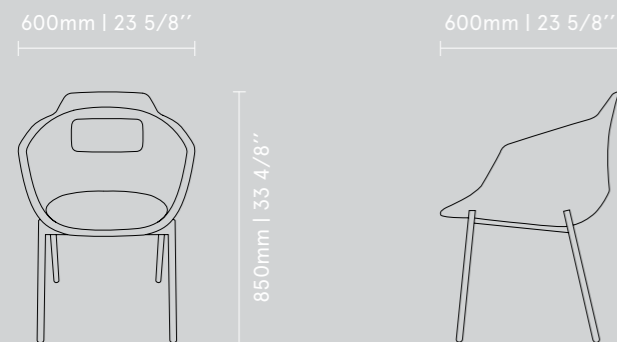





**ULTRA F armchair with P7 base**  
600 / 600 / 850  
19 5/8" / 23 5/8" / 33 4/8"



**ULTRA F armchair with P11KT base**  
600 / 600 / 850  
19 5/8" / 23 5/8" / 33 4/8"

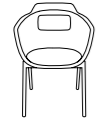

**ULTRA F armchair with P11KT base**  
600 / 600 / 850  
19 5/8" / 23 5/8" / 33 4/8"





**ULTRA F armchair with P7 base**  
600 / 600 / 850  
19 5/8" / 23 5/8" / 33 4/8"



**ULTRA F armchair with P7KT base**  
600 / 600 / 850  
19 5/8" / 23 5/8" / 33 4/8"

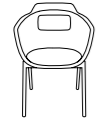

**ULTRA F armchair with P1 base**  
600 / 600 / 850  
19 5/8" / 23 5/8" / 33 4/8"



Ultra Colours

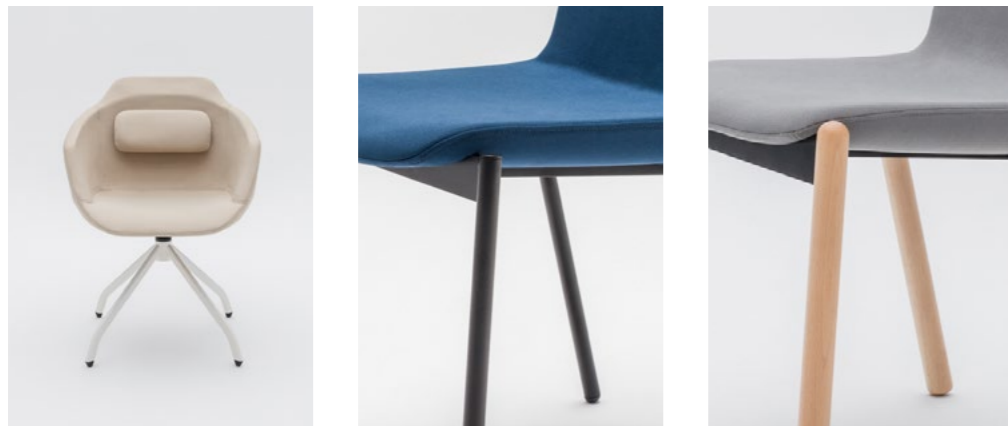

Images in the catalogue may show products slightly differently from the original version. Colours of shown materials may differ from the real ones. The producer reserves a right to introduce change of colours and patterns of the presented products. The manufacturer reserves the right to introduce alterations to the products and their marking without changing the general design. The present catalogue does not constitute a legally binding offer and is published solely for information purposes. Order may be placed only on the basis of the current price lists, available at authorised distributors.

