

KOLORYSTYKA

BIURKA

Blat

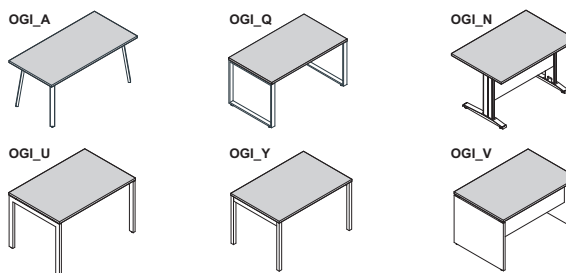

Blenda, Nogi płytowe

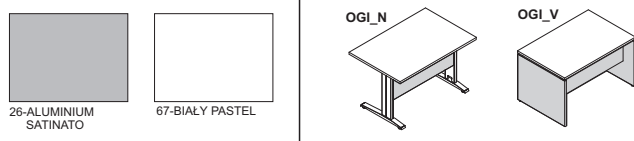

Stelaż

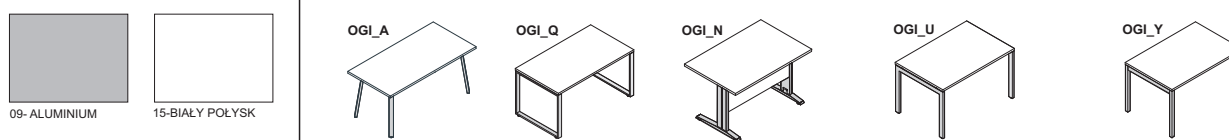

BIURKO Z SZAFKĄ MANAGERSKĄ

Blat, Wieniec górny, Wieniec dolny

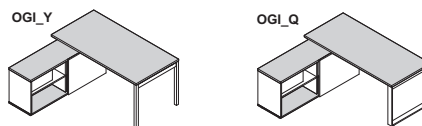

Front

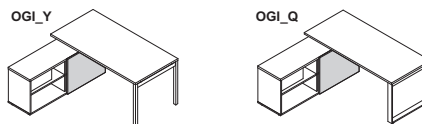

Korpus

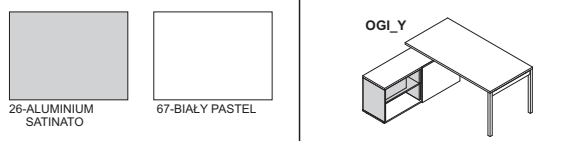

I - GRUPA CENOWA : kolorystyka standardowa



II - GRUPA CENOWA : kolorystyka opcjonalna

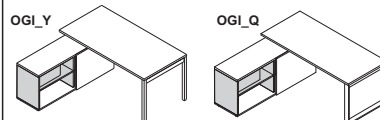

KOLORYSTYKA

Przeloty kablowe

OPIS TECHNICZNY

1 BIURKO

1.1 BLAT

plyta melaminowana 28mm

blat bez przelotów kablowych

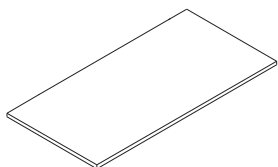

blat z przelotami kablowymi

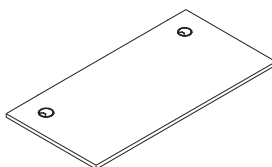

blat bez przelotów kablowych z M04 lub M05

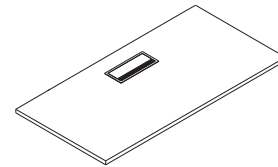

1.2 STELAŻ

OGI_A

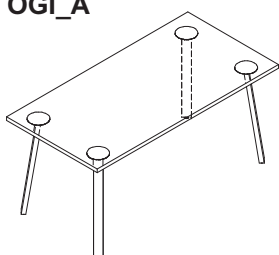

Stelaż

metal malowany proszkowo profil 30x60mm

OGI_Q

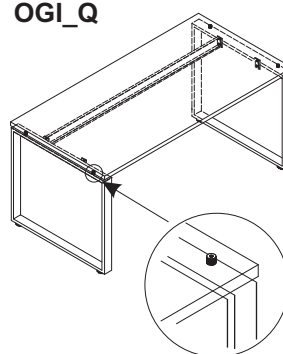

Stelaż

metal malowany proszkowo profil 60x20mm połączony belką konstrukcyjną, regulacja poziomu

dystans między blatem biurka a stelażem 15mm

OGI_U

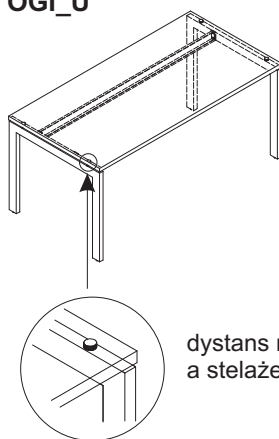

Stelaż

metal malowany proszkowo profil 30x60mm

dystans między blatem biurka a stelażem 10mm

OGI_Y

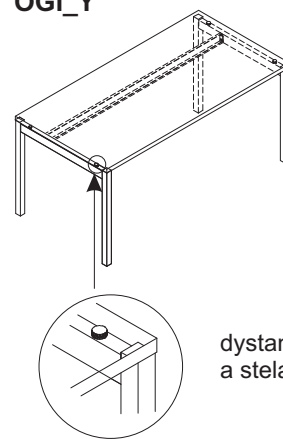

Stelaż

metal malowany proszkowo profil 40x40mm nogi łączone profilem poprzecznym

dystans między blatem biurka a stelażem 10mm

OGI_N

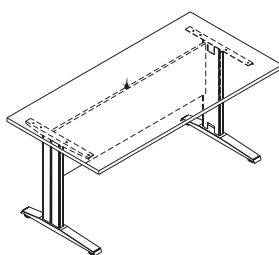

Stelaż

stelaż z pionowym prowadzeniem okablowania na bazie nóg kolumnowych

Ośłona płytowa

plyta melaminowana 18mm

OGI_V

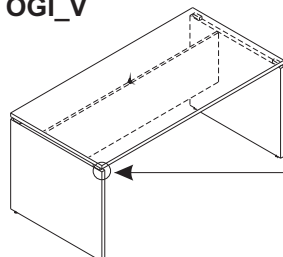

Nogi płytowe

plyta melaminowana 28mm

Między blatem biurka a nogą dystans aluminiowy 20x60mm

Ośłona płytowa

plyta melaminowana 18mm

OPIS TECHNICZNY

2 BIURKO MANAGERSKIE

2.1 BLAT, WIENIEC GÓRNY

plyta melaminowana 28mm PVC 2mm

2.2 KORPUS, FRONT

plyta melaminowana 18mm

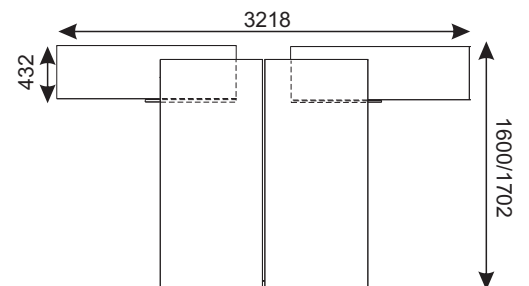
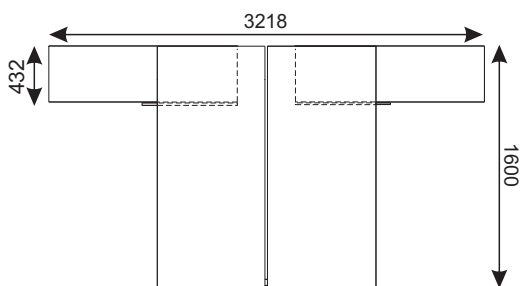
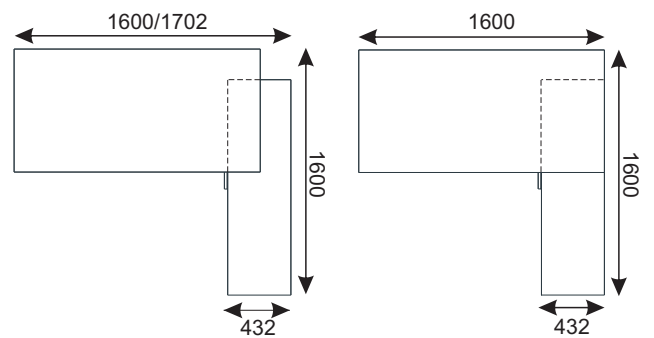
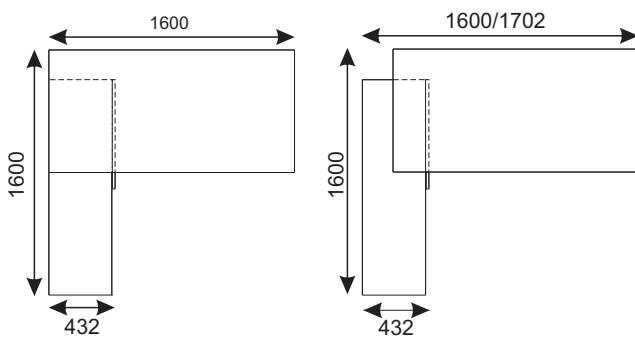
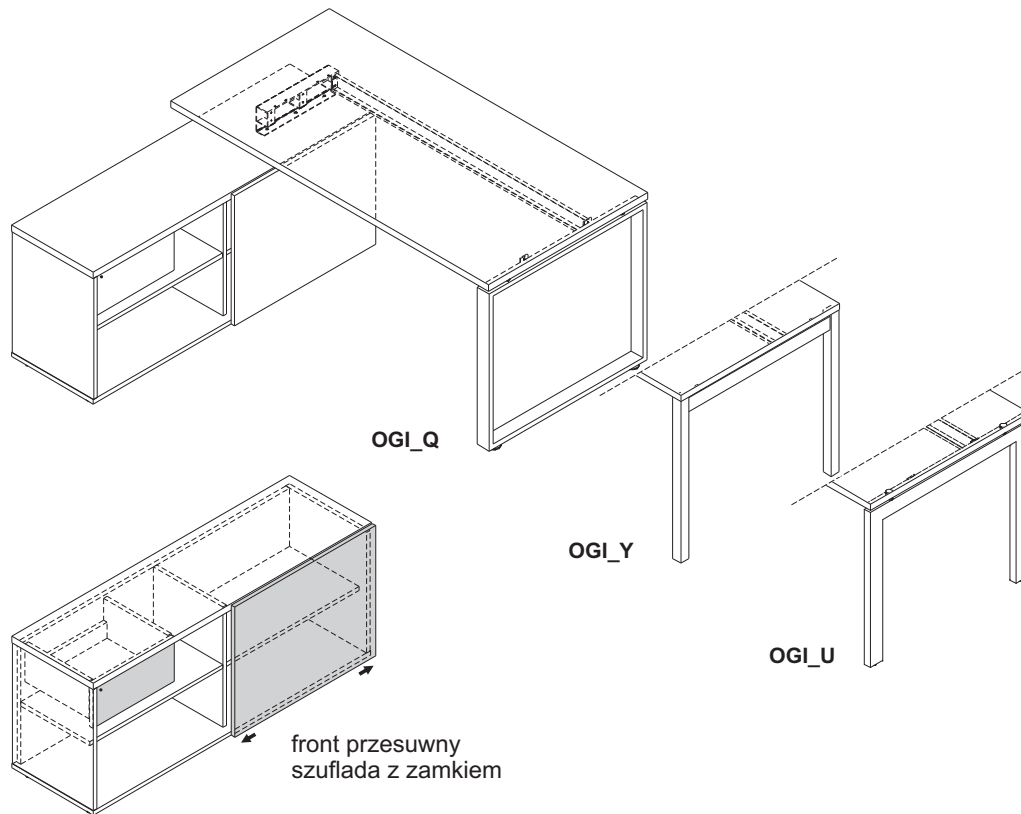

OPIS TECHNICZNY

3 ELEMENTY UZUPEŁNIAJĄCE

3.1 PRZELOTY KABLOWE PVC

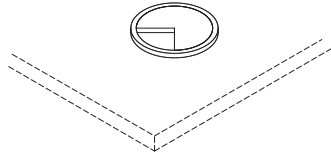

3.2 TOP ACCESS M05 ALUMINIUM

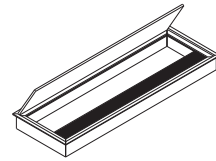
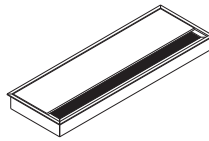
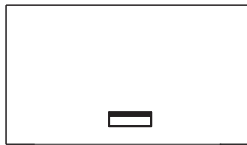

3.3 MEDIABOX M04 ALUMINIUM

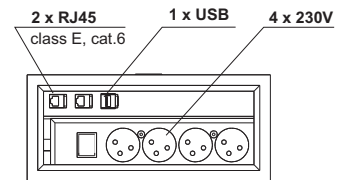
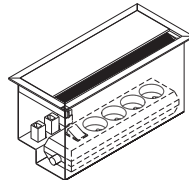
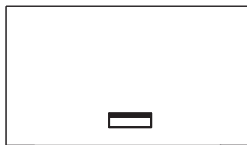

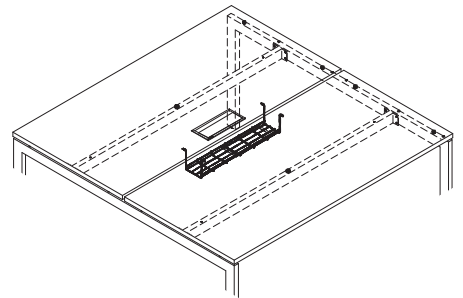
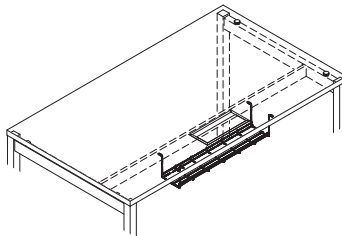
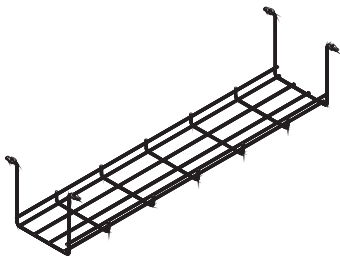

3.4 SZYNA KABLOWA S69
metal malowany proszkowo



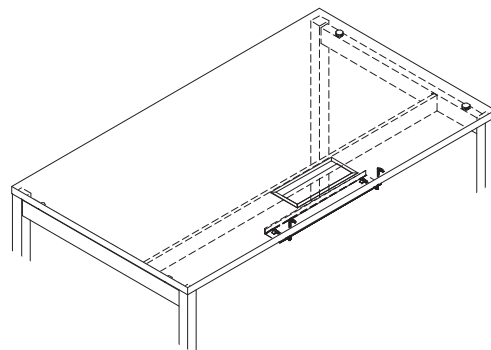
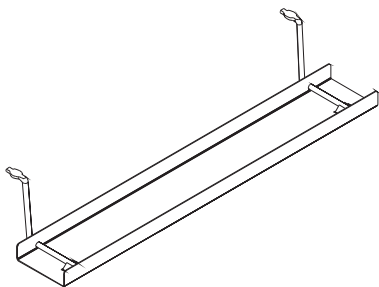





3.5 SZYNA KABLOWA E64
metal malowany proszkowo





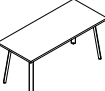

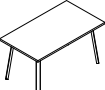
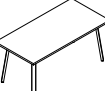
WIDOK i RZUT OBIEKTU	WYMIARY [mm]			SYMBOL	CENA NETTO PLN				UWAGI
	SZEROKOŚĆ	GŁĘBOKOŚĆ	WYSOKOŚĆ			kg	m3	szt	

BIURKA PROSTE

	1200	600	740	BAG026	480,-	59.9	0.146	8	
	1400	600	740	BAG036	495,-	56.3	0.159	8	
	1600	600	740	BAG046	510,-	62.3	0.173	8	
	1200	700	740	BAG027	500,-	56.3	0.159	8	
	1400	700	740	BAG037	515,-	65.3	0.174	8	
	1600	700	740	BAG047	530,-	71.3	0.190	8	
	1200	800	740	BAG028	520,-	64.3	0.172	8	
	1400	800	740	BAG038	535,-	71.3	0.189	8	
	1600	800	740	BAG048	555,-	80.3	0.207	8	



DODATKOWA DOPLATA DO CECHY

CECHA	SYMBOL												UWAGI
	BAG026	BAG036	BAG046	BAG027	BAG037	BAG047	BAG028	BAG038	BAG048	kg	m3	szt	
PRZEŁOTY KABLOWE	40,-	40,-	40,-	40,-	40,-	40,-	40,-	40,-	40,-	0.1	0.0001	1	
MEDIABOX M04	450,-	450,-	450,-	450,-	450,-	450,-	450,-	450,-	450,-	0.9	0.0070	1	
TOP ACCESS M05	150,-	150,-	150,-	150,-	150,-	150,-	150,-	150,-	150,-	0.9	0.0070	1	

LEGENDA:
 - WAGA NETTO

 - OBJĘTOŚĆ



 - ILOŚĆ PACZEK

WIDOK i RZUT OBIEKTU	WYMIARY [mm]			SYMBOL	CENA NETTO PLN				UWAGI
	SZEROKOŚĆ	GLĘBOKOŚĆ	WYSOKOŚĆ			kg	m3	szt	

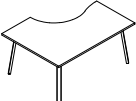
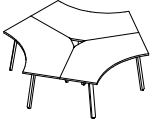

BIURKA KSZTAŁTOWE

	1600	1200	740	BAG10	665,-	37.7	0.135	5	
	1600	1200	740	BAG11	665,-	37.5	0.135	5	
	2343	2029	740	BAG12	1 470,-	93.6	0.325	15	

PANELE

	780	18	350	ZP78	240,-	4.0	0.008	1	
	780	46	350	ZP78P	450,-	6.0	0.028	1	



DODATKOWA DOPLATA DO CECHY

CECHA	SYMBOL												UWAGI
	BAG10	BAG11								kg	m3	szt	
PRZELOTY KABLOWE	40,-	40,-								0.1	0.0001	1	
MEDIABOX M04	450,-	450,-								0.9	0.0070	1	
TOP ACCESS M05	150,-	150,-								0.9	0.0070	1	

LEGENDA:
 - WAGA NETTO

 - OBJĘTOŚĆ



 - ILOŚĆ PACZEK

WIDOK i RZUT OBIEKTU	WYMIARY [mm]			SYMBOL	CENA NETTO PLN				UWAGI
	SZEROKOŚĆ	GŁĘBOKOŚĆ	WYSOKOŚĆ			kg	m3	szt	

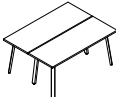
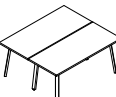
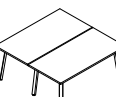
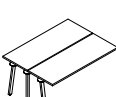
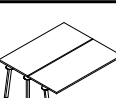
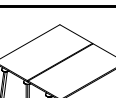
UKŁADY BIUREK OGI_A

	1600	1218	740	BAG214	850,-	120.6	0.313	14	
	1600	1418	740	BAG216	895,-	138.6	0.347	14	
	1600	1618	740	BAG218	935,-	156.6	0.381	14	
	1600	1218	740	BAG414	600,-	114.6	0.265	11	element do rozbudowy układów
	1600	1418	740	BAG416	640,-	132.6	0.299	11	element do rozbudowy układów
	1600	1618	740	BAG418	685,-	150.6	0.333	11	element do rozbudowy układów



DODATKOWA DOPLATA DO CECHY

CECHA	SYMBOL										UWAGI
	BAG214	BAG216	BAG218	BAG414	BAG416	BAG418		kg	m3	szt	
PRZELOTY KABLOWE	80,-	80,-	80,-	80,-	80,-	80,-		0.1	0.0001	1	
MEDIABOX M04	900,-	900,-	900,-	900,-	900,-	900,-		0.9	0.0070	1	
TOP ACCESS M05	300,-	300,-	300,-	300,-	300,-	300,-		0.9	0.0070	1	





LEGENDA:
 - WAGA NETTO

 - OBJĘTOŚĆ

 - ILOŚĆ PACZEK

WIDOK i RZUT OBIEKTU	WYMIARY [mm]			SYMBOL	CENA NETTO PLN				UWAGI
	SZEROKOŚĆ	GLĘBOKOŚĆ	WYSOKOŚĆ			kg	m3	szt	



BIURKA PROSTE

	1200	800	740	BQG02	790,-	36.8	0.132	4	
	1400	800	740	BQG03	815,-	41.1	0.137	4	
	1600	800	740	BQG04	830,-	45.0	0.145	4	
	1800	800	740	BQG05	860,-	49.7	0.152	5	

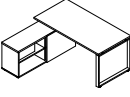
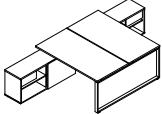
BIURKA Z SZAFKĄ MANAGERSKĄ

	1702 1600	1600 1600	740 740	BQG20	1 650,-	96.7	0.256	9	
	1702 1600	3218 3218	740 740	BQG40	3 280,-	188.8	0.525	18	



DODATKOWA DOPLATA DO CECHY

CECHA	SYMBOL										UWAGI
	BQG02	BQG03	BQG04	BQG05	BQG20	BQG40	kg	m3	szt		
PRZELOTY KABLOWE	40,-	40,-	40,-	40,-	40,-	80,-	0.1	0.0001	1		
MEDIABOX M04	450,-	450,-	450,-	450,-	450,-	900,-	0.9	0.0070	1		
TOP ACCESS M05	150,-	150,-	150,-	150,-	150,-	300,-	0.9	0.0070	1		
II GRUPA CENOWA					75,-	150,-	0.0	0.0000	0		

LEGENDA:
 - WAGA NETTO

 - OBJĘTOŚĆ

 - ILOŚĆ PACZEK

WIDOK i RZUT OBIEKTU	WYMIARY [mm]			SYMBOL	CENA NETTO PLN				UWAGI
	SZEROKOŚĆ	GŁĘBOKOŚĆ	WYSOKOŚĆ			kg	m3	szt	

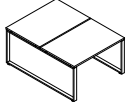
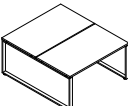
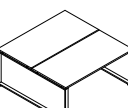
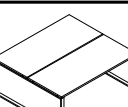

UKŁADY BIUREK OGI_Q

	1200	1618	740	BQG32	1 420,-	66.1	0.292	8	
	1400	1618	740	BQG33	1 470,-	74.8	0.304	8	
	1600	1618	740	BQG34	1 500,-	82.6	0.318	8	
	1800	1618	740	BQG35	1 545,-	90.8	0.324	6	

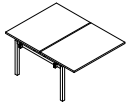
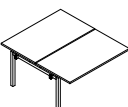
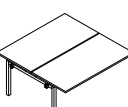
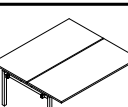
ELEMENTY DO ROZBUDOWY UKŁADÓW

	1200	1618	740	BQG62	1 330,-	50.1	0.149	7	
	1400	1618	740	BQG64	1 380,-	58.2	0.156	5	
	1600	1618	740	BQG66	1 425,-	66.0	0.170	5	
	1800	1618	740	BQG68	1 470,-	74.8	0.180	5	

DODATKOWA DOPLATA DO CECHY

CECHA	SYMBOL											UWAGI
	BQG32	BQG33	BQG34	BQG35	BQG62	BQG64	BQG66	BQG68	kg	m3	szt	
PRZELOTY KABLOWE	80,-	80,-	80,-	80,-	80,-	80,-	80,-	80,-	0.1	0.0001	1	
MEDIABOX M04	900,-	900,-	900,-	900,-	900,-	900,-	900,-	900,-	0.9	0.0070	1	
TOP ACCESS M05	300,-	300,-	300,-	300,-	300,-	300,-	300,-	300,-	0.9	0.0070	1	

LEGENDA:
 - WAGA NETTO

 - OBJĘTOŚĆ

 - ILOŚĆ PACZEK

WIDOK i RZUT OBIEKTU	WYMIARY [mm]			SYMBOL	CENA NETTO PLN				UWAGI
	SZEROKOŚĆ	GLĘBOKOŚĆ	WYSOKOŚĆ			kg	m3	szt	

BIURKA PROSTE

	1200	800	740	BNG02	475,-	32.6	0.100	3	
	1400	800	740	BNG03	495,-	37.0	0.108	3	
	1600	800	740	BNG04	520,-	41.9	0.122	3	
	1800	800	740	BNG05	550,-	45.3	0.124	3	

BIURKA KSZTAŁTOWE

	1600	1200	740	BNG10	660,-	46.6	0.145	3	należy zastosować odpowiednią nogę podpierającą
	1600	1200	740	BNG11	660,-	46.3	0.145	3	należy zastosować odpowiednią nogę podpierającą
	1800	1200	740	BNG17	745,-	52.9	0.149	3	należy zastosować odpowiednią nogę podpierającą
	1800	1200	740	BNG18	745,-	52.9	0.149	3	należy zastosować odpowiednią nogę podpierającą

DODATKOWA DOPLATA DO CECHY

CECHA	SYMBOL											UWAGI
	BNG02	BNG03	BNG04	BNG05	BNG10	BNG11	BNG17	BNG18	kg	m3	szt	
PRZEŁOTY KABLOWE	40,-	40,-	40,-	40,-	40,-	40,-	40,-	40,-	0.1	0.0001	1	
MEDIABOX M04	450,-	450,-	450,-	450,-	450,-	450,-	450,-	450,-	0.9	0.0070	1	
TOP ACCESS M05	150,-	150,-	150,-	150,-	150,-	150,-	150,-	150,-	0.9	0.0070	1	

LEGENDA:

- WAGA NETTO

- OBJĘTOŚĆ

- ILOŚĆ PACZEK

WIDOK i RZUT OBIEKTU	WYMIARY [mm]			SYMBOL	CENA NETTO PLN				UWAGI
	SZEROKOŚĆ	GLEBOKOŚĆ	WYSOKOŚĆ			kg	m3	szt	

BIURKA PROSTE

	1200	800	740	BUG19	655,-	31.0	0.084	3	
	1400	800	740	BUG20	670,-	37.3	0.089	3	
	1600	800	740	BUG21	685,-	39.2	0.096	3	
	1800	800	740	BUG22	760,-	43.6	0.102	3	

BIURKA KSZTAŁTOWE

	1600	1200	740	BUG23	810,-	43.9	0.119	3	należy zastosować odpowiednią nogę podpierającą
	1600	1200	740	BUG24	810,-	43.7	0.119	3	należy zastosować odpowiednią nogę podpierającą
	1800	1200	740	BUG25	915,-	51.2	0.127	3	należy zastosować odpowiednią nogę podpierającą
	1800	1200	740	BUG26	960,-	51.2	0.127	3	należy zastosować odpowiednią nogę podpierającą
	1600	2418	740	BUG15	1 460,-	85.2	0.238	5	należy zastosować odpowiednią nogę podpierającą

DODATKOWA DOPLATA DO CECHY



CECHA	SYMBOL												UWAGI
	BUG19	BUG20	BUG21	BUG22	BUG23	BUG24	BUG25	BUG26	BUG15	kg	m3	szt	
PRZEŁOTY KABLOWE	40,-	40,-	40,-	40,-	40,-	40,-	40,-	40,-	80,-	0.1	0.0001	1	
MEDIABOX M04	450,-	450,-	450,-	450,-	450,-	450,-	450,-	450,-	900,-	0.9	0.0070	1	
TOP ACCESS M05	150,-	150,-	150,-	150,-	150,-	150,-	150,-	150,-	300,-	0.9	0.0070	1	

LEGENDA:

- WAGA NETTO

- OBJĘTOŚĆ

- ILOŚĆ PACZEK

WIDOK i RZUT OBIEKTU	WYMIARY [mm]			SYMBOL	CENA NETTO PLN				UWAGI
	SZEROKOŚĆ	GŁĘBOKOŚĆ	WYSOKOŚĆ			kg	m3	szt	

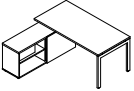
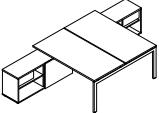

BIURKA Z SZAFKĄ MANAGERSKĄ

	1702 1600	1600 1600	740 740	BUL20	1 450,-	93.7	0.238	9	
	1702 1600	3218 3218	740 740	BUL40	2 900,-	183.2	0.472	16	

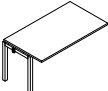
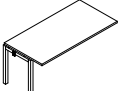
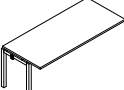
ELEMENTY DO ROZBUDOWY UKŁADÓW

	1200	800	740	BUG42	570,-	25.8	0.073	3	
	1400	800	740	BUG43	580,-	32.1	0.079	3	
	1600	800	740	BUG44	595,-	34.0	0.086	3	
	1800	800	740	BUG45	630,-	38.4	0.091	3	

DODATKOWA DOPLATA DO CECHY



CECHA	SYMBOL										UWAGI
	BUL20	BUL40	BUG42	BUG43	BUG44	BUG45		kg	m3	szt	
PRZELOTY KABLOWE	40,-	80,-	40,-	40,-	40,-	40,-		0.1	0.0001	1	
MEDIABOX M04	450,-	900,-	450,-	450,-	450,-	450,-		0.9	0.0070	1	
TOP ACCESS M05	150,-	300,-	150,-	150,-	150,-	150,-		0.9	0.0070	1	
II GRUPA CENOWA	75,-	150,-						0.0	0.0000	0	

LEGENDA:

 - WAGA NETTO

 - OBJĘTOŚĆ

 - ILOŚĆ PACZEK

WIDOK i RZUT OBIEKTU	WYMIARY [mm]			SYMBOL	CENA NETTO PLN				UWAGI
	SZEROKOŚĆ	GŁĘBOKOŚĆ	WYSOKOŚĆ			kg	m3	szt	

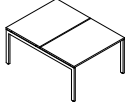
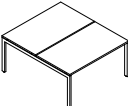
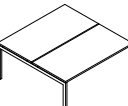
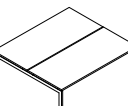

UKŁADY BIUREK OGI_U

	1200	1618	740	BUG32	1 145,-	59.5	0.167	5	
	1400	1618	740	BUG33	1 175,-	72.2	0.178	5	
	1600	1618	740	BUG34	1 210,-	76.0	0.193	5	
	1800	1618	740	BUG35	1 240,-	84.8	0.203	5	

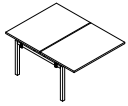
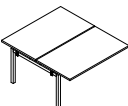
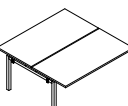
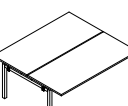
ELEMENTY DO ROZBUDOWY UKŁADÓW

	1200	1618	740	BUG62	1 040,-	49.5	0.144	5	
	1400	1618	740	BUG64	1 065,-	62.2	0.156	5	
	1600	1618	740	BUG66	1 095,-	66.0	0.170	5	
	1800	1618	740	BUG68	1 120,-	74.8	0.181	5	

DODATKOWA DOPLATA DO CECHY

CECHA	SYMBOL											UWAGI
	BUG32	BUG33	BUG34	BUG35	BUG62	BUG64	BUG66	BUG68	kg	m3	szt	
PRZEŁOTY KABLOWE	80,-	80,-	80,-	80,-	80,-	80,-	80,-	80,-	0.1	0.0001	1	
MEDIABOX M04	900,-	900,-	900,-	900,-	900,-	900,-	900,-	900,-	0.9	0.0070	1	
TOP ACCESS M05	300,-	300,-	300,-	300,-	300,-	300,-	300,-	300,-	0.9	0.0070	1	

LEGENDA:
 - WAGA NETTO

 - OBJĘTOŚĆ

 - ILOŚĆ PACZEK

WIDOK i RZUT OBIEKTU	WYMIARY [mm]			SYMBOL	CENA NETTO PLN				UWAGI
	SZEROKOŚĆ	GLEBOKOŚĆ	WYSOKOŚĆ			kg	m3	szt	

BIURKA PROSTE

	1200	800	740	BYG02	525,-	30.8	0.071	3	
	1400	800	740	BYG03	545,-	34.1	0.077	3	
	1600	800	740	BYG04	570,-	37.0	0.084	3	
	1800	800	740	BYG05	610,-	40.4	0.089	3	

BIURKA KSZTAŁTOWE

	1600	1200	740	BYG10	685,-	12.0	0.036	2	należy zastosować odpowiednią nogę podpierającą
	1600	1200	740	BYG11	685,-	41.5	0.106	3	należy zastosować odpowiednią nogę podpierającą
	1800	1200	740	BYG17	770,-	48.0	0.114	3	należy zastosować odpowiednią nogę podpierającą
	1800	1200	740	BYG18	770,-	48.0	0.114	3	należy zastosować odpowiednią nogę podpierającą
	1600	2418	740	BYG15	1 155,-	78.2	0.251	5	należy zastosować odpowiednią nogę podpierającą

DODATKOWA DOPLATA DO CECHY



CECHA	SYMBOL												UWAGI
	BYG02	BYG03	BYG04	BYG05	BYG10	BYG11	BYG17	BYG18	BYG15	kg	m3	szt	
PRZEŁOТЫ KABLOWE	40,-	40,-	40,-	40,-	40,-	40,-	40,-	40,-	80,-	0.1	0.0001	1	
MEDIABOX M04	450,-	450,-	450,-	450,-	450,-	450,-	450,-	450,-	900,-	0.9	0.0070	1	
TOP ACCESS M05	150,-	150,-	150,-	150,-	150,-	150,-	150,-	150,-	300,-	0.9	0.0070	1	

LEGENDA:

- WAGA NETTO

- OBJĘTOŚĆ

- ILOŚĆ PACZEK

WIDOK i RZUT OBIEKTU	WYMIARY [mm]			SYMBOL	CENA NETTO PLN				UWAGI
	SZEROKOŚĆ	GŁĘBOKOŚĆ	WYSOKOŚĆ			kg	m3	szt	

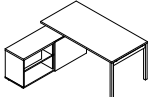
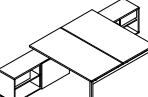

BIURKA Z SZAFKĄ MANAGERSKĄ

	1702	1600	740	BYL20	1 355,-	92.7	0.244	9		układ uniwersalny, lewy lub prawy
	1600	1600	740							
	1702	3218	740	BYL40	2 605,-	181.2	0.473	16		
	1600	3218	740							

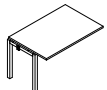
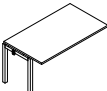
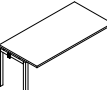
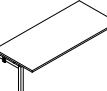
ELEMENTY DO ROZBUDOWY UKŁADÓW

	1200	800	740	BYG42	455,-	25.8	0.073	3		
	1400	800	740	BYG43	475,-	29.1	0.079	3		
	1600	800	740	BYG44	495,-	32.0	0.086	3		
	1800	800	740	BYG45	530,-	35.4	0.091	3		



DODATKOWA DOPLATA DO CECHY

CECHA	SYMBOL										UWAGI		
	BYL20	BYL40	BYG42	BYG43	BYG44	BYG45				kg		m3	szt
PRZEŁOTY KABLOWE	40,-	80,-	40,-	40,-	40,-	40,-				0.1	0.0001	1	
MEDIABOX M04	450,-	900,-	450,-	450,-	450,-	450,-				0.9	0.0070	1	
TOP ACCESS M05	150,-	300,-	150,-	150,-	150,-	150,-				0.9	0.0070	1	
II GRUPA CENOWA	75,-	150,-								0.0	0.0000	0	

LEGENDA:
 - WAGA NETTO

 - OBJĘTOŚĆ

 - ILOŚĆ PACZEK

WIDOK i RZUT OBIEKTU	WYMIARY [mm]			SYMBOL	CENA NETTO PLN				UWAGI
	SZEROKOŚĆ	GŁĘBOKOŚĆ	WYSOKOŚĆ			kg	m3	szt	

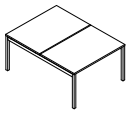
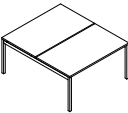
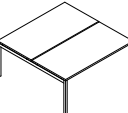
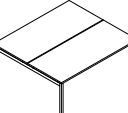

UKŁADY BIUREK OGI_Y

	1200	1618	740	BYG32	965,-	56.5	0.180	5	
	1400	1618	740	BYG33	1 020,-	63.2	0.191	5	
	1600	1618	740	BYG34	1 060,-	69.0	0.206	5	
	1800	1618	740	BYG35	1 115,-	75.8	0.216	5	

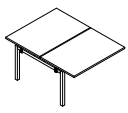
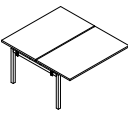
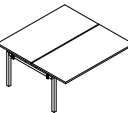
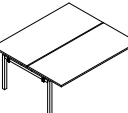
ELEMENTY DO ROZBUDOWY UKŁADÓW

	1200	1618	740	BYG62	935,-	49.5	0.144	5	
	1400	1618	740	BYG64	975,-	56.2	0.156	5	
	1600	1618	740	BYG66	1 025,-	62.0	0.170	5	
	1800	1618	740	BYG68	1 070,-	68.8	0.181	5	



DODATKOWA DOPLATA DO CECHY

CECHA	SYMBOL											UWAGI
	BYG32	BYG33	BYG34	BYG35	BYG62	BYG64	BYG66	BYG68	kg	m3	szt	
PRZEŁOTY KABLOWE	80,-	80,-	80,-	80,-	80,-	80,-	80,-	80,-	0.1	0.0001	1	
MEDIABOX M04	900,-	900,-	900,-	900,-	900,-	900,-	900,-	900,-	0.9	0.0070	1	
TOP ACCESS M05	300,-	300,-	300,-	300,-	300,-	300,-	300,-	300,-	0.9	0.0070	1	





LEGENDA:
 - WAGA NETTO

 - OBJĘTOŚĆ





 - ILOŚĆ PACZEK

WIDOK i RZUT OBIEKTU	WYMIARY [mm]			SYMBOL	CENA NETTO PLN				UWAGI
	SZEROKOŚĆ	GŁĘBOKOŚĆ	WYSOKOŚĆ			kg	m3	szt	



BIURKA PROSTE

	1200	800	740	BVG02	395,-	45.3	0.096	3	
	1400	800	740	BVG03	425,-	49.6	0.104	3	
	1600	800	740	BVG04	460,-	53.5	0.113	3	
	1800	800	740	BVG05	510,-	57.9	0.120	3	

BIURKA KSZTAŁTOWE

	1600	1200	740	BVG10	640,-	58.2	0.135	3	
	1600	1200	740	BVG11	640,-	58.0	0.135	3	
	1800	1200	740	BVG17	685,-	65.5	0.145	3	
	1800	1200	740	BVG18	685,-	65.5	0.145	3	

DODATKOWA DOPLATA DO CECHY

CECHA	SYMBOL											UWAGI
	BVG02	BVG03	BVG04	BVG05	BVG10	BVG11	BVG17	BVG18	kg	m3	szt	
PRZELOTY KABLOWE	40,-	40,-	40,-	40,-	40,-	40,-	40,-	40,-	0.1	0.0001	1	
MEDIABOX M04	450,-	450,-	450,-	450,-	450,-	450,-	450,-	450,-	0.9	0.0070	1	
TOP ACCESS M05	150,-	150,-	150,-	150,-	150,-	150,-	150,-	150,-	0.9	0.0070	1	

LEGENDA:

 - WAGA NETTO

 - OBJĘTOŚĆ

 - ILOŚĆ PACZEK

WIDOK i RZUT OBIEKTU	WYMIARY [mm]			SYMBOL	CENA NETTO PLN					UWAGI
	SZEROKOŚĆ	GLĘBOKOŚĆ	WYSOKOŚĆ			kg	m3	szt		
	80	80	23	PK80	30,-	0.0	0.000	1		przełot kablowy 02-szary,08-czarny,67-biały
	275	120	140	M04	450,-	0.0	0.000	0		4x230V, 2xRJ45, 1xUSB
	275	120	25	M05	150,-	0.3	0.002	1		TOP ACCESS
	460	110	121	E64	65,-	0.0	0.000	0		kanal kablowy 09-aluminium
	580	162	123	S69	75,-	1.0	0.015	1		09 - aluminium
	140	70	750	S81	125,-	1.1	0.008	1		przewodzenie kabli (kręgosłup) kolor 09-aluminium
	1000	70	35	S82	65,-	1.0	0.005	1		grzeblen do mocowania kabli pod blatem, 09-aluminium
				AK3	30,-	0.2	0.000	1		rzepy do mocowania kabli, 02-szary(3 z wkretami, 3 bez wkretów)
				AK5	35,-	0.2	0.000	1		zaczep do prowadzenia kabla 5szt., 08-czarny

LEGENDA:

- WAGA NETTO

- OBJĘTOŚĆ

- ILOŚĆ PACZEK

WIDOK i RZUT OBIEKTU	WYMIARY [mm]			SYMBOL	CENA NETTO PLN					UWAGI
	SZEROKOŚĆ	GLĘBOKOŚĆ	WYSOKOŚĆ			kg	m3	szt		

AKCESORIA

	212	460	617	S83	130,-	2.7	0.027	1		zawieszak do komputera, 09-aluminium, 15- biały połysk
	220	470	148	S73	140,-	3.2	0.002	1		wózek do komputera, 26-aluminium satynato
	610	400	85	C01	125,-	0.5	0.010	1		półka pod klawiaturę do biurka na gł. 800mm, 02-szary

LEGENDA:

- WAGA NETTO

- OBJĘTOŚĆ

- ILOŚĆ PACZEK